

Compression Clamps

Compression clamps for guide rail are available in plastic or aluminum.
(Fasteners not included)

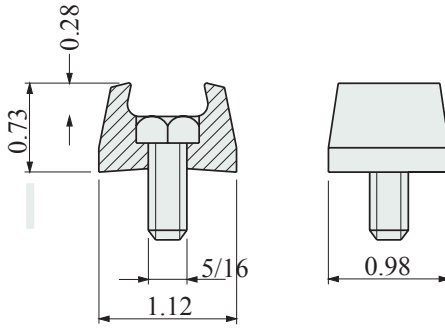

Part #	Material
275-664151	Polyamide
275-AL	Aluminum

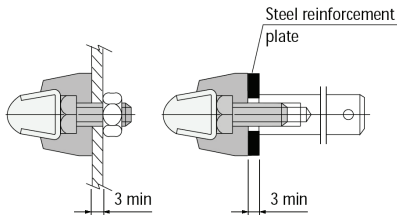
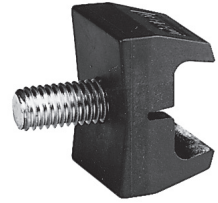

Back Plate Part # 275-BP

Backplate in stainless steel AISI 304, for compression clamp series 275.

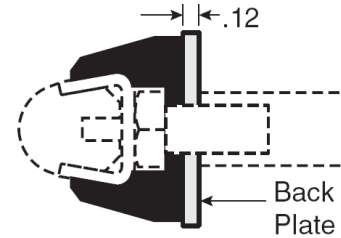
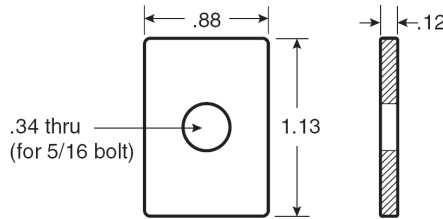

Splice Sleeves

Splice sleeve for guide rail, supplied in stainless steel AISI 304

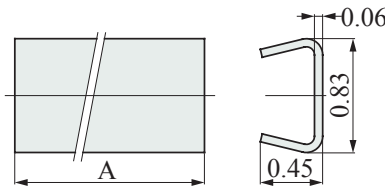
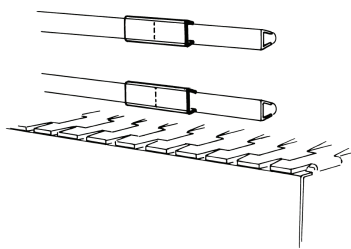

Part #	A
214-60111	2"
214-60113	3"



ViseSplice™ sleeve for guide rail, supplied in stainless steel AISI 304

Part # 902-656041

