

Flexible Roller Guide

Part # 580-603302

- Material : frame in acetal POM (black).
Rollers in polyamide PA (white).

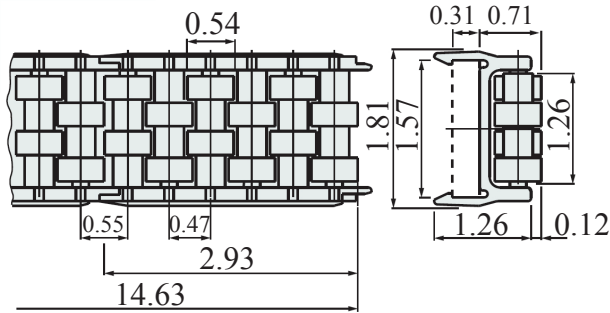
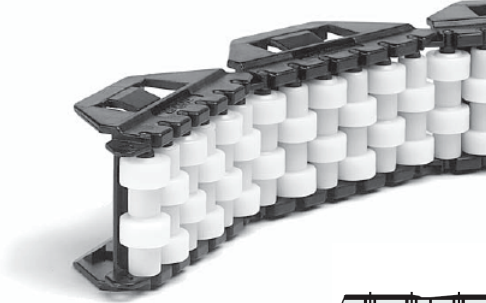

Fixing of Part #580
Snap-on assembly / disassembly

- Fixing with plate.

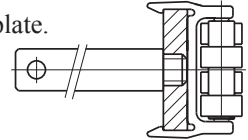

- Fixing with metal profile Part #537

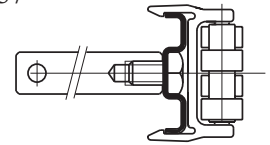

• Min. curvature radius Part. 580

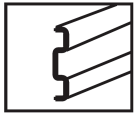
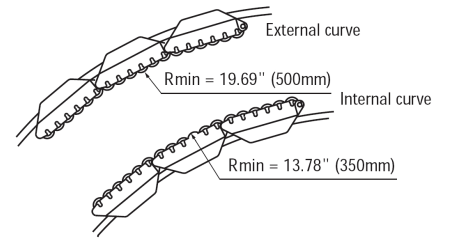

Part #537 - Metal profile 1.575" x 0.31"

Metal Profile

Part # 537-689231

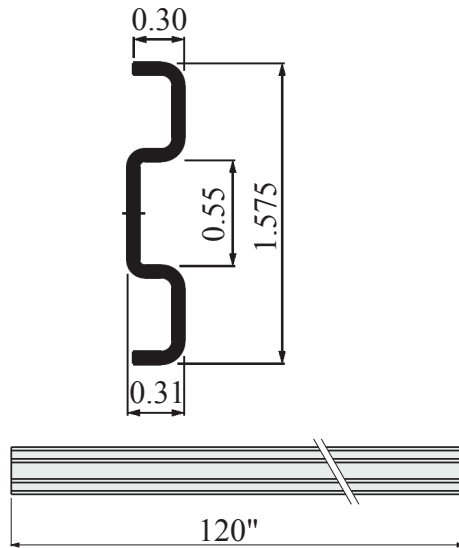

- Material : Stainless steel

